

FIRE DOOR LOCKS AND PANIC EXIT DEVICES

Cylinder mortice locks.....	407
Panic function cylinder mortice locks	409
Cylinder mortice locks.....	411
Panic function cylinder mortice locks	412
Extended bolts for additional locking points.....	414
Panic exit devices with black painted case cover for panic function locks	415
Touch-bar panic exit devices for panic function locks.....	417
Touch-bar PVD panic exit devices for panic function locks	418
Electric handles	419
Horizontal bars for panic exit devices	420
Accessories for fire door locks	421
Dimensional drawings.....	425



TYPE	CONTROLS	OPERATION	
<p>A</p> <p>OUTSIDE ENTRANCE BY KEY</p> <p>For doors which have to be opened with the key from the outside by authorized personnel only</p>	<p>INSIDE</p> <ul style="list-style-type: none"> -Panic exit device to open. -Key to close with dead-bolt. <p>OUTSIDE</p> <ul style="list-style-type: none"> -The key operates latch and deadbolt. 	<p>1 Outside entrance by key only.</p>	<p>2</p> <p>Locking with the deadbolt, outside entrance is possible only with the use of the key.</p>
<p>B</p> <p>OUTSIDE HANDLE ACTIVATED OR DISACTIVATED</p> <p>For doors that open outwards and places where it is necessary to provide free entrance.</p>	<p>INSIDE</p> <ul style="list-style-type: none"> -Panic exit device to open. -Key to close with dead-bolt and activate or deactivate the outside handle. <p>OUTSIDE</p> <ul style="list-style-type: none"> -The key operates the dead-bolt and activates or deactivates the outside handle for latch operation. 	<p>1 The outside handle is activated by rotating the key in the lock-opening direction as far as it will go (the handle remains activated when the key is removed).</p>	<p>2</p> <p>Closing with the dead-bolt deactivates the outside handle; the latter remains deactivated even after the door has been opened with the panic exit device.</p>
<p>C</p> <p>OUTSIDE HANDLE AUTOMATICALLY DISACTIVATED</p> <p>For doors that must be opened from the outside only by authorized persons.</p>	<p>INSIDE</p> <ul style="list-style-type: none"> -Panic exit device to open. -Key to close with dead-bolt. <p>OUTSIDE</p> <ul style="list-style-type: none"> -The key operates the throw and activates the handle. 	<p>1 The outside handle is activated by rotating the key in the lock-opening direction as far as it will go, after first withdrawing the dead-bolt.</p>	<p>2</p> <p>Removing the key automatically deactivates the outside handle.</p>
<p>D</p> <p>OUTSIDE HANDLE ALWAYS ACTIVATED</p> <p>For doors that partition throughways (e.g. corridors).</p>	<p>INSIDE</p> <ul style="list-style-type: none"> -Panic exit device to open. -Key to close with dead-bolt. <p>OUTSIDE</p> <ul style="list-style-type: none"> -The key operates the dead-bolt. The handle, with the dead-bolt withdrawn, engages for latch operation. 	<p>1 The outside handle is always activated when the dead-bolt is withdrawn.</p>	<p>2</p> <p>Entry is after using the panic exit device, always possible from the outside as long as the dead-bolt is not activated by the key.</p>

Technical features:

- Zinc plated steel faceplate
- Zinc plated steel case
- Zinc plated steel latch
- 9 mm. through follower

Hand:
0 = Non-handed

Cylinder to be ordered separately

Type	Description	Throws	Centre Distance	Faceplate	Backset	Unit weight 	Pieces 	ITEM			
								Type	Dim.	Hand	Fin. Pers. Spec.

	<ul style="list-style-type: none"> • Latch bolt only • OPERATION: -Latch withdrawn by key or handle 	-	72	24	65	0,770	24	1	43000	65	0
--	---	---	----	----	----	-------	----	---	-------	----	---

	<ul style="list-style-type: none"> • Dead-bolt and latch • 15 mm. throw • OPERATION: -Latch withdrawn by key or handle -Dead-bolt withdrawn by key 	1	72	24	65	0,826	24	1	43020	65	0
--	---	---	----	----	----	-------	----	---	-------	----	---

	<ul style="list-style-type: none"> • Dead-bolt and latch • 15 mm. throw • Pre-arranged for additional locking points • OPERATION: -Latch withdrawn by key or handle -Dead-bolt operated by key • ON REQUEST: -Set of side latches item 1.07090.50.0 -Set of rods item 1.07091.50.0 	1	72	24	65	0,850	24	1	43024	65	0
--	---	---	----	----	----	-------	----	---	-------	----	---

Type	Description	Throws	Centre Distance	Faceplate	Backset	Unit weight Kg	Pieces	ITEM			
								Type	Dim.	Hand	Fin.

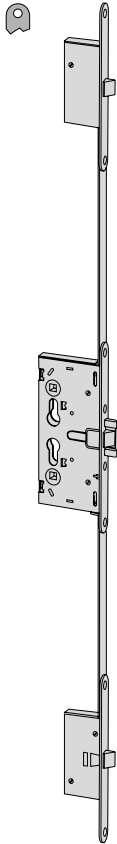

- Dead-bolt and latch
- 15 mm throw
- 3 locking points
- OPERATION:
 - Latch withdrawn by key or handle
 - Dead-bolt operated by key

1	72	24	65	1,750	24	1	43025	65	0
---	----	----	----	-------	----	---	-------	----	---

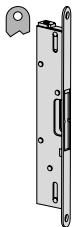

- FOR SECONDARY LEAF OF A DOUBLE DOOR
- OPERATION:
 - Extended bolts are operated by a front lever located inside the striker
- ON REQUEST:
 - Extended bolts item 1.07088.03.0
 - Automatic dogging device item 1.07089.50.0

-	1	24	-	0,390	1	1	43090	00	0
---	---	----	---	-------	---	---	-------	----	---



Technical features:

- Zinc plated steel faceplate
- Zinc plated steel case
- Zinc plated steel latch
- 9 mm. split follower
- Can be combined with the panic exit devices series 59600 and 59710

Hand:
0 = Non-handed

Cylinder to be ordered separately



Type	Description	Throws	Centre Distance	Faceplate	Backset	Unit weight 	Pieces 	ITEM			
								Type	Dim.	Hand	Fin.

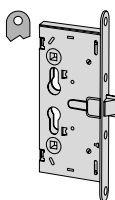

- Latch bolt only
- OPERATION:
Inside: panic exit device and/or key
Outside: the key activates and disactivates handle and withdraws latch
Handle withdraws latch only if activated by the key

72	24	65	0,845	6	1	43110	65	0
----	----	----	-------	---	---	-------	----	---

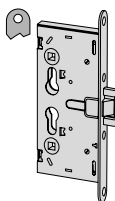

- Dead-bolt and latch
- 15 mm throw
- OPERATION:
Inside: panic exit device and/or key
Outside: the key withdraws latch and dead-bolt

1	72	24	65	0,820	6	1	43120	65	0
---	----	----	----	-------	---	---	-------	----	---

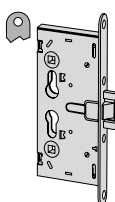

- Dead-bolt and latch
- 15 mm throw
- OPERATION:
Inside: panic exit device and/or key
Outside: the key withdraws latch and dead-bolt, latch withdrawn by handle

1	72	24	65	0,820	6	1	43130	65	0
---	----	----	----	-------	---	---	-------	----	---

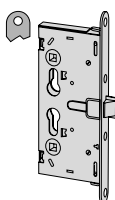

- Latch only
- Pre-arranged for additional locking points
- ON REQUEST:
Zinc plated extended bolts item 1.07091.50.0
Set of zinc plated side latches item 1.07090.50.0
- OPERATION:
Inside: panic exit device and/or key
Outside: the key activates and disactivates handle and withdraws latch
Handle withdraws latch only if activated by the key

72	24	65	0,850	6	1	43114	65	0
----	----	----	-------	---	---	-------	----	---

Type	Description	Throws	Centre Distance	Faceplate Backset	Unit weight Kg	Pieces	ITEM			
							Type	Dim. Hand	Fin.	Pers. Spec.

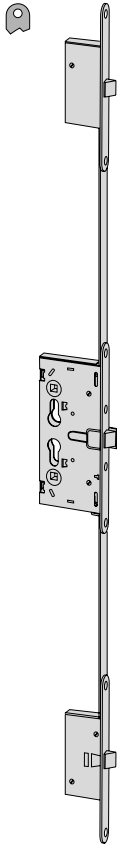

- Latches only
- 3 locking points
- OPERATION:
 Inside: panic exit device and/or key
 Outside: the key activates and disactivates handle and withdraws latches
 Handle withdraws latches only if activated by the key

72	24	65	1,750	6	1 43115 65 0
----	----	----	-------	---	--------------

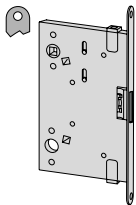

- FOR SECONDARY LEAF OF A DOUBLE DOOR
- A latch only lock to be installed on main leaf, item 1.43110.65.0 or 1.43115.65.0
- OPERATION:
 Inside: panic exit device
- ON REQUEST:
 Extended bolts item 1.07088.03.0
 Automatic dogging device 1.07089.50.0

1	24	65	0,858	1	1 43190 65 0
1	24	95	1,000	1	1 43190 95 0



Technical features:

- Zinc plated steel faceplate
- Zinc plated steel case
- Nickel-plated reversible steel latch with anti-picking device
- Single throw (15 mm.) nickel-plated dead-bolt
- 9 mm. through follower

Supplied as standard:

- Instruction sheet

Hand:
0 = Non-handed

Cylinder to be ordered separately



Type	Description	Throws	Centre Distance	Faceplate	Backset	Unit weight 	Pieces 	ITEM			
								Type	Dim.	Hand	Fin.

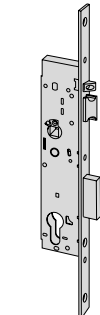

- Dead-bolt and latch
- OPERATION:
Outside and inside: latch and dead-bolt operated by key; latch withdrawn by handle
- Dead-bolt and latch
- OPERATION:
Outside and inside: the key operates the dead-bolt and activates or disactivates the handle for latch operation

1	92	24	25	0,680	1	1	43520	25	0		
1	92	24	30	0,720	1	1	43520	30	0		
1	92	24	35	0,775	1	1	43520	35	0		
1	92	24	40	0,805	1	1	43520	40	0		
1	92	24	45	1,000	1	1	43520	45	0		
1	92	24	25	0,680	1	1	43530	25	0		
1	92	24	30	0,720	1	1	43530	30	0		
1	92	24	35	0,775	1	1	43530	35	0		
1	92	24	40	0,805	1	1	43530	40	0		
1	92	24	45	1,000	1	1	43530	45	0		



CE **P**
ICIM

Technical features:

- Zinc plated steel faceplate
- Zinc plated steel case
- Nickel-plated reversible steel latch
- Single throw (15 mm.) nickel-plated dead-bolt
- 9 mm. split follower
- Can be combined with the panic exit devices series 59600 and 59710



Supplied as standard:

- Instruction sheet

Hand:
0 = Non-handed

Cylinder to be ordered separately

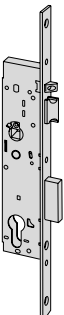

Type	Description	Throws	Centre Distance	Faceplate	Backset	Unit weight 	Pieces 	ITEM							
								Type	Dim.	Hand	Fin.	Pers.	Spec.		
 <ul style="list-style-type: none"> • FOR SINGLE LEAF DOORS • Dead-locking latch and dead-bolt • A TYPE OPERATION • Inside: <ul style="list-style-type: none"> -Panic exit device for opening -Key for closing with dead-bolt • Outside: <ul style="list-style-type: none"> -Key for activating latch and dead-bolt <ul style="list-style-type: none"> • B TYPE OPERATION • Inside: <ul style="list-style-type: none"> -Panic exit device for opening -Key for closing with dead-bolt and activating or disactivating external handle for latch operation • Outside: <ul style="list-style-type: none"> -Key for closing with dead-bolt and activating or disactivating external handle for latch operation <ul style="list-style-type: none"> • C TYPE OPERATION • Inside: <ul style="list-style-type: none"> -Panic exit device for opening -Key for closing with dead-bolt and activating external handle for latch operation • Outside: <ul style="list-style-type: none"> -Key for closing with dead-bolt and activating external handle for latch operation <ul style="list-style-type: none"> • D TYPE OPERATION • Inside: <ul style="list-style-type: none"> -Panic exit device for opening -Key for closing with dead-bolt • Outside: <ul style="list-style-type: none"> -Key for closing with dead-bolt. The handle, with dead-bolt withdrawn, is activated for latch operation 	1	92	24	25	0,610	1	1	43620	25	0					
	1	92	24	30	0,655	1	1	43620	30	0					
	1	92	24	35	0,690	1	1	43620	35	0					
	1	92	24	40	0,730	1	1	43620	40	0					
	1	92	24	45	0,780	1	1	43620	45	0					
	1	92	24	25	0,610	1	1	43630	25	0					
	1	92	24	30	0,655	1	1	43630	30	0					
	1	92	24	35	0,690	1	1	43630	35	0					
	1	92	24	40	0,730	1	1	43630	40	0					
	1	92	24	45	0,780	1	1	43630	45	0					
	1	92	24	25	0,610	1	1	43631	25	0					
	1	92	24	30	0,655	1	1	43631	30	0					
	1	92	24	35	0,690	1	1	43631	35	0					
	1	92	24	40	0,730	1	1	43631	40	0					
	1	92	24	45	0,780	1	1	43631	45	0					
1	92	24	25	0,610	1	1	43632	25	0						
1	92	24	30	0,655	1	1	43632	30	0						
1	92	24	35	0,690	1	1	43632	35	0						
1	92	24	40	0,730	1	1	43632	40	0						
1	92	24	45	0,780	1	1	43632	45	0						

Type	Description	Throws	Centre Distance	Faceplate	Backset	Unit weight 	Pieces 	ITEM			
								Type	Dim.	Hand	Fin.

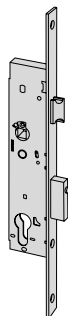

- FOR DOUBLE DOORS
- Panic lock series 43290 to be installed on secondary leaf
- Dead-bolt and latch
- A TYPE OPERATION
- Inside:
 - Panic exit device for opening
 - Key for closing with dead-bolt
- Outside:
 - Key for activating latch and dead-bolt

1	92	24	25	0,560	1	1	43650 25 0
1	92	24	30	0,610	1	1	43650 30 0
1	92	24	35	0,725	1	1	43650 35 0
1	92	24	40	0,770	1	1	43650 40 0
1	92	24	45	0,710	1	1	43650 45 0

- B TYPE OPERATION
- Inside:
 - Panic exit device for opening
 - Key for closing with dead-bolt and activating or disactivating external handle for latch operation
- Outside:
 - Key for closing with dead-bolt and activating or disactivating external handle for latch operation

1	92	24	25	0,640	1	1	43660 25 0
1	92	24	30	0,610	1	1	43660 30 0
1	92	24	35	0,725	1	1	43660 35 0
1	92	24	40	0,760	1	1	43660 40 0
1	92	24	45	0,710	1	1	43660 45 0

- C TYPE OPERATION
- Inside:
 - Panic exit device for opening
 - Key for closing with dead-bolt and activating external handle for latch operation
- Outside:
 - Key for closing with dead-bolt and activating external handle for latch operation

1	92	24	25	0,560	1	1	43661 25 0
1	92	24	30	0,610	1	1	43661 30 0
1	92	24	35	0,640	1	1	43661 35 0
1	92	24	40	0,670	1	1	43661 40 0
1	92	24	45	0,710	1	1	43661 45 0

- D TYPE OPERATION
- Inside:
 - Panic exit device for opening
 - Key for closing with dead-bolt
- Outside:
 - Key for closing with dead-bolt. The handle, with dead-bolt withdrawn, is activated for latch operation

1	92	24	25	0,560	1	1	43662 25 0
1	92	24	30	0,610	1	1	43662 30 0
1	92	24	35	0,715	1	1	43662 35 0
1	92	24	40	0,760	1	1	43662 40 0
1	92	24	45	0,710	1	1	43662 45 0



- FOR SECONDARY LEAF OF A DOUBLE DOOR
- Panic lock series 43650, 43660, 43661, 43662 to be installed on secondary leaf
- OPERATION:
- Inside:panic exit device
- ON REQUEST:
 - Extended bolts item 1.07088.03.0
 - Automatic dogging device item 1.07089.50.0
 - Top striker item 1.06141.80.0

-	92	24	30	0,795	1	1	43690 30 0
-	92	24	40	0,865	1	1	43690 40 0
-	92	24	60	1,020	1	1	43690 60 0
-	92	24	75	1,100	1	1	43690 75 0

Type	Description	For series/item	 Unit weight  Pieces	ITEM				
				Type	Dim.	Hand	Fin.	Pers. Spec.

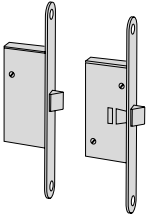

• Set of zinc plated side latches

1 43024 65 0, 1	0,900	24	1 07090 50 0
43114 65 0			

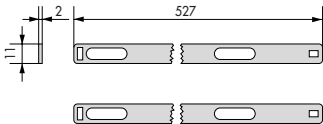

• Set of zinc plated rods

1 07090 50 0	0,230	24	1 07091 50 0
--------------	-------	----	--------------



Technical features:

- Black painted aluminium casings or black nylon
- Internal, zinc-plated steel components, suitable for fire doors

Supplied as standard:

- Fixing screws
- Instruction sheet for assembly and maintenance
- CE and ICIM certification

Standards:

- CE mark in compliance with the DIRECTIVE 89/106/CEE issued by AENOR.
- Voluntary ICIM certification issued by third party as provided for in the UNI EN 1125 standard

Hand:

0 = Non-handed

Bar to be ordered separately



series 07007

Type	Description	Spindle hole	Centre Distance	Unit weight 	Pieces 	ITEM			
						Type	Dim.	Hand	Fin. Per. Spec.

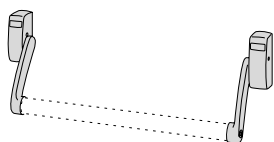

- Black painted aluminium casing
- May be combined with mortice locks series 43100, 43600

9 2,700 1 1 59605 00 0

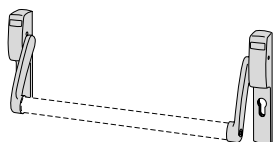

- Black nylon casing
- May be combined with mortice locks series 43100, 43600

9 2,700 1 1 59606 00 0

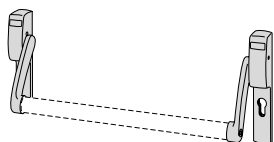

- Black painted aluminium casing
- May be combined with mortice locks series 43100

9 72 1,900 1 1 59615 00 0

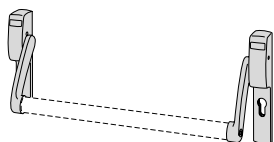

- Black painted aluminium casing
- May be combined with mortice locks series 43600

9 92 2,750 1 1 59615 12 0

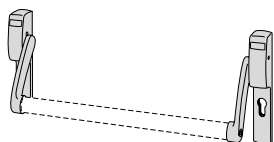

- Black nylon casing
- May be combined with mortice locks series 43100, 43600
- Pre-arranged for single cylindr

9 72 2,750 1 1 59616 00 0

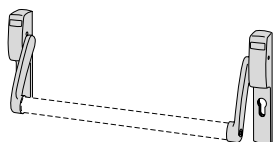

- Black nylon casing
- May be combined with mortice locks series 43100
- Pre-arranged for double cylindr

9 72 2,750 1 1 59616 10 0

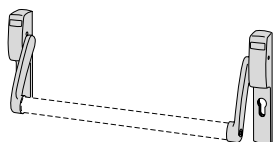

- Black nylon casing
- May be combined with mortice locks series 43600
- Pre-arranged for double cylindr

9 92 2,750 1 1 59616 12 0

Type	Description	Spindle hole	Centre Distance	Unit weight Kg	Pieces	ITEM				
						Type	Dim.	Hand	Fin.	Pers.
	<ul style="list-style-type: none"> • Black painted aluminium case cover • FOR THE SECONDARY LEAF OF A DOUBLE DOOR, where it is not possible to assemble the safety lock • On the main door it is possible to install the panic exit devices series 59615 together with the locks series 43110 and 43114 • SUPPLIED AS STANDARD: Striker art. 1.07072.11.0 Floor striker art. 1.07073.11.0 • TO BE ORDERED SEPARATELY: Pair of extended bolts art. 1.07081.12.0 	-		2,800	1	1	59646	00	0	
	<ul style="list-style-type: none"> • Black nylon cover • FOR THE SECONDARY LEAF OF A DOUBLE DOOR, where it is not possible to assemble the safety lock • On the main door it is possible to install the panic exit devices series 59615 together with the locks series 43110 and 43114 • SUPPLIED AS STANDARD: Striker art. 1.07072.11.0 Floor striker art. 1.07073.11.0 • TO BE ORDERED SEPARATELY Pair of extended bolts art. 1.07081.12.0 	-		4,800	1	1	59647	00	0	



Technical features:

- Black lacquered aluminium casing
- Internal, zinc plated steel components, suitable for fire doors
- Bar in aluminium alloy, can be shortened to 300 mm

Supplied as standard:

- Fixing screws
- Installation templates
- Instruction sheet

On request:

- Version with microswitch (LA suffix)

Finishes:

- STANDARD: black case, red bar
- ON REQUEST: red case, black bar (fin. 41)

yellow case, black bar (fin. 42)

green case, black bar (fin. 43)

white case, black bar (fin. 45)

grey case, grey bar (fin. 97)

- AVAILABLE BAR COLOUR FINISHES (at an extra charge):

anodized, satin aluminium (AL suffix)

anodized, satin bronze (BR suffix)

brass plated (OT suffix)

painting green (VE suffix)

painting white (BI suffix)

painting grey (GR suffix)

Standards:

- Manufactured in conformity with the European standard UNI/EN 1125 on escape doors equipment

Hand:

0 = Non-handed

Type	Description	Spindle hole	L	Unit weight	Pieces	ITEM			
						Type	Dim.	Hand	Fin.

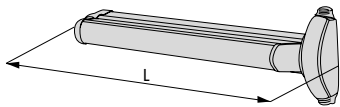

- May be combined with panic locks series 43100

- May be combined with panic function mortice locks series 43200, 52760, 52761, 52840, 52842, 52844, 52860, 52862, 52864 (for assembly with fire resistant locks specify Spec. FR in your order)

9	1200	4,600	1	1 59710 00 0				
9	840	4,600	1	1 59710 01 0				
8	1200	4,600	1	1 59710 10 0				
8	840	4,600	1	1 59710 11 0				



SBLOCK PVD

Technical features:

- Aluminium case cover and bar with PVD coating.
- Bar can be shortened up 300 mm

Supplied as standard:

- Fixing screws
- Installation and maintenance instruction sheet
- ICIM and CE Certification

On request:

- Version with microswitch (spec. LA)

Finishes:

- Satin finish stainless steel (fin.C2)

Standards:

- CE mark in compliance with the DIRECTIVE 89/106/CEE issued by AENOR.

- Voluntary ICIM certification issued by third party as provided for in the UNI EN 1125 standard.

Hand:

0 = Non-handed

Type	Description	Spindle hole	L	Unit weight 	Pieces 	ITEM				
						Type	Dim.	Hand	Fin.	Pers. Spec.
	<ul style="list-style-type: none"> • May be combined with panic function fire resistant mortice locks series 43100 	9	1200	4,600	1	1	59710	00	0	C2
		9	840	4,600	1	1	59710	01	0	C2
	<ul style="list-style-type: none"> • May be combined with panic function mortice locks series 43200, 43600, 52800, 52760, 52761 (for assembly with fire resistant locks specify Spec. FR in your order) 	8	1200	4,600	1	1	59710	10	0	C2
		8	840	4,600	1	1	59710	11	0	C2



Technical features:

- Operating voltage
 - 12V ac (item: 1.07074.50/52.0)
 - 12 V cc (item: 1.07074.60/62.0)
- Zinc plated steel case
- Painted aluminium case cover

Supplied as standard:

- Power cable
- Handle spindle 8/9
- Fixing screws
- Assembly instruction sheet

On request:

- Open door indicator led item 1-07126-00-0
- Metal spacer item 1.07126.50.0 for use with Touch-bar series panic exit devices

Finishes:

- Black case cover

Hand:

0 = Non-hande

Type	Description	Facplate	Unit weight	Pieces	ITEM			
					Type	Dim.	Hand	Fin.

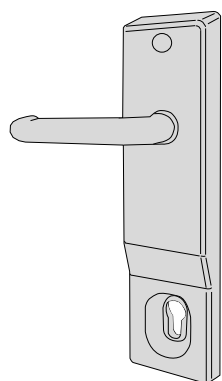

- VERSION WITH HOLD-OPEN CATCH MECHANISM
- To be used with series 43100 locks with handle/cylinder distance of 72 mm
- VERSION WITH HOLD-OPEN CATCH MECHANISM
- To be used with series 43200, 43600 locks with handle/cylinder distance of 92 mm
- VERSION WITHOUT HOLD-OPEN CATCH MECHANISM
- To be used with series 43100 locks with handle/cylinder distance of 72 mm
- VERSION WITHOUT HOLD-OPEN CATCH MECHANISM
- To be used with series 43200, 43600 locks with handle/cylinder distance of 92 mm

2,200	1	1 07074 50 0
2,605	1	1 07074 52 0
1,690	1	1 07074 60 0
1,690	1	1 07074 62 0

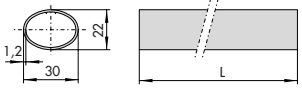
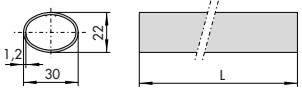
Type	Description	L	Unit weight Kg	Pieces	ITEM			
					Type	Dim.	Hand	Fin.
 <ul style="list-style-type: none"> • Red painted steel oval shaped bar • AVAILABLE FINISHES (extra price): <ul style="list-style-type: none"> -yellow painted (fin. 42) -green painted (fin. 43) -black painted (fin. 44) -white painted (fin. 45) -grey painted (fin. 97) 	900	0,800	1	1	07007	13	0	
	1200	1,100	1	1	07007	14	0	
	1500	1,450	1	1	07007	15	0	
	<hr/>							
 <ul style="list-style-type: none"> • Stainless steel oval shaped horizontal bar 	900	0,800	1	1	07007	60	0	
	1200	0,800	1	1	07007	61	0	
	1500	0,900	1	1	07007	62	0	

Type	Description	For series/item	Unit weight 	Pieces 	ITEM			
					Type	Dim.	Hand	Fin.
	<ul style="list-style-type: none"> Floor striker 	43290, 43690, 43190	60	6	1	06142	85	0
	<ul style="list-style-type: none"> Set of plates with cylinder hole 	43000, 43020	0,200	6	1	07070	12	0
	<ul style="list-style-type: none"> Set of plates with fixed handle knob and cylinder hole 	43000, 43020, 43025	0,340	6	1	07070	14	0
	<ul style="list-style-type: none"> Set of plates with handles 	43000, 43020, 43025	0,410	6	1	07070	15	0
	<ul style="list-style-type: none"> Set of plates with handles and cylinder hole 	43000, 43020, 43025	0,679	6	1	07070	16	0
	<ul style="list-style-type: none"> Cylinder adaptor for bit keys (patent type) SUPPLIED AS STANDARD: Bitted key Fixing screws 2 nylon escutcheons with plug, to be combined with handles series 1.07070.12/14/16 	43000, 43020, 43025	0,066	6	1	07071	10	0
	<ul style="list-style-type: none"> Zinc plated steel striker 	43000, 43100	0,050	20	1	07073	20	0

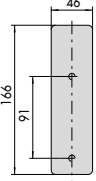
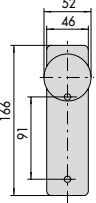
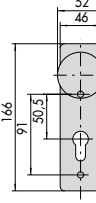
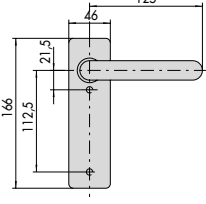
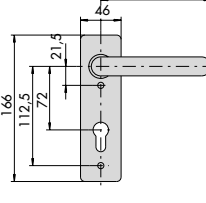
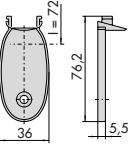
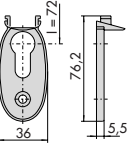
Type	Description	For series/item	Unit weight Kg	Pieces	ITEM			
					Type	Dim.	Hand	Fin.
	<ul style="list-style-type: none"> • Outside plate for reinforced assembly • To be combined with panic exit devices series 59600 and 59710 with distance 72 mm 	43110, 43115, 43120, 43130	0,204	6	1	07076	11	0
	<ul style="list-style-type: none"> • Outside plate with fixed knob • To be combined with panic exit devices series 59600 and 59710 with distance 72 mm 	43110, 43115, 43120, 43130	0,160	6	1	07076	13	0
	<ul style="list-style-type: none"> • Outside plate with fixed knob and cylinder hole • To be combined with panic exit devices series 59600 and 59710 with distance 72 mm 	43110, 43115, 43120, 43130	0,160	6	1	07076	14	0
	<ul style="list-style-type: none"> • Outside plate with handle • To be combined with panic exit devices series 59600 and 59710 with distance 72 mm 	43110, 43115, 43120, 43130	0,250	6	1	07076	15	0
	<ul style="list-style-type: none"> • Outside plate with handle and cylinder hole • To be combined with panic exit devices series 59600 and 59710 with distance 72 mm 	43110, 43115, 43120, 43130	0,400	6	1	07076	16	0
	<ul style="list-style-type: none"> • Black painted inside plate • To be combined with locks with distance 72 mm 	59710	0,250	6	1	07076	60	0
	<ul style="list-style-type: none"> • Black painted inside plate with cylinder hole • To be combined with locks with distance 72 mm 	59710	0,117	6	1	07076	61	0

Type	Description	For series/item	Unit weight Kg	Pieces	ITEM				
					Type	Dim.	Hand	Fin.	Pers.
	<ul style="list-style-type: none"> • Black painted steel extended bolts • For use with: Panic exit devices series 59646, 59695, 59185 		1,130	1	1 07081 12 0				
	• Steel split spindle		0,060	6	1 07083 50 0				
	• Steel split spindle		0,060	6	1 07083 51 0				
	• Steel split spindle		0,060	6	1 07083 52 0				
	• Steel split spindle		0,060	6	1 07083 53 0				
	• Steel spindle		0,030	6	1 07083 70 0				
	• Steel spindle		0,060	1	1 07085 75 0				
	• Steel spindle		0,060	1	1 07085 76 0				
	• Automatic dogging device, steel	43090, 43190, 43690	0,060	3	1 07089 50 0				

Type	Description	For series/item	Unit weight Kg	Pieces	ITEM			
					Type	Dim.	Hand	Peris. Spec.

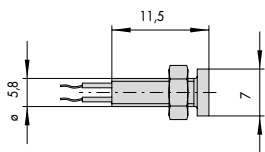

- Open door indicator

07074 0,005 1 1 07126 01 0

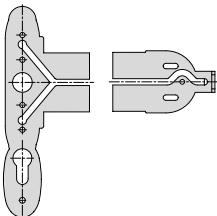

- Steel spacer
- Can be combined with touch-bar panic device

59710 0,200 1 1 07126 50 0

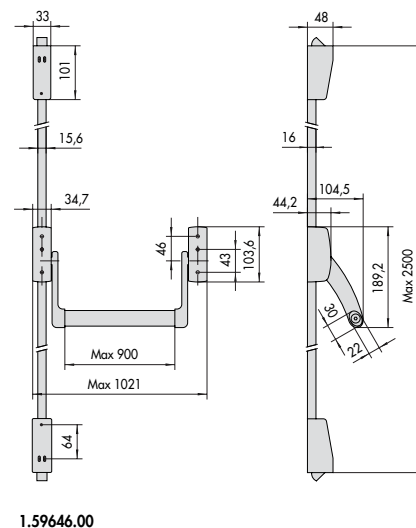
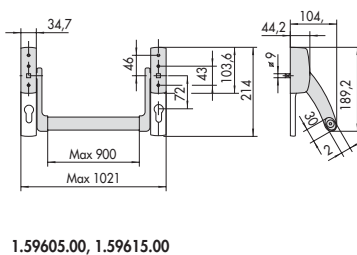
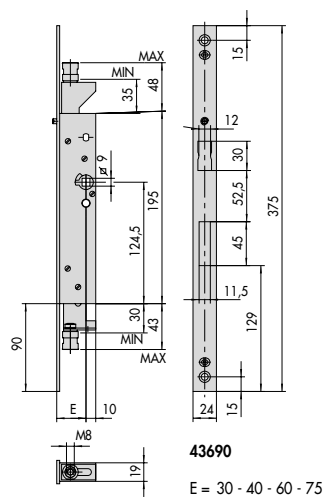

10

11

12

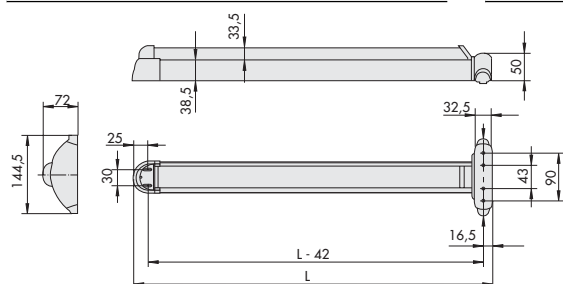

13